



whiteline®

COMPOSITE DOORS

Sanctuary





Just 4 steps to your perfect entrance

- 1 Choose your door design
- 2 Choose your door colour
- 3 Choose your glass design
- 4 Choose your hardware

With a range of designs to give your home the presence it deserves, a selection of colours to perfectly fit your personality and a choice of glazing to add that extra sparkle; you won't just open the door when you get home - you'll feel like you've arrived.



*Start designing your
bespoke door with our
door visualiser feature*



<https://build-your-door.com/whiteline/sanctuary/about>



We all want to keep our energy consumption to a minimum, not just because of the rising costs, but also our awareness of it's impact on the environment.

Saving energy

One of the best ways we can reduce energy bills is to choose thermally-efficient doors and windows for our homes - keeping the warmth in and the cold out. This not only saves money but it also helps reduce our emission levels.

We all want to keep our energy consumption to a minimum, not just because of the rising cost of energy bills but also our awareness of the impact on the environment.

One of the best ways we can achieve this is to choose thermally-efficient doors and windows for our homes - keeping the warmth in and the cold out. This not only saves money but it also helps reduce our emission levels.

The timber rails that make up the perimeter of the door retain some warmth and insulation.

The 'fielded' panels that make up most of the face of the door release a lot of valuable heat from indoors.

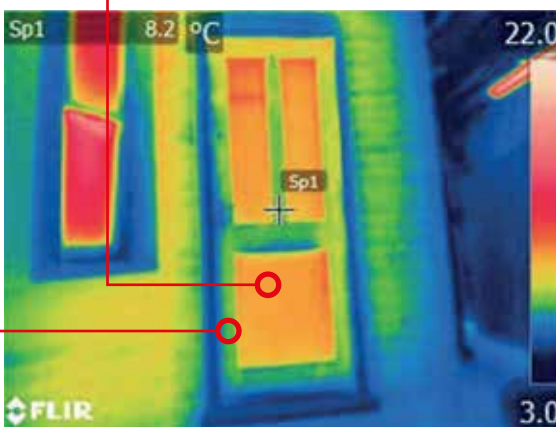

Traditional timber-panelled door

Sanctuary proves to be the most effective insulator thanks to its dense foam core. The outer face stays cold meaning your heat has been retained indoors.

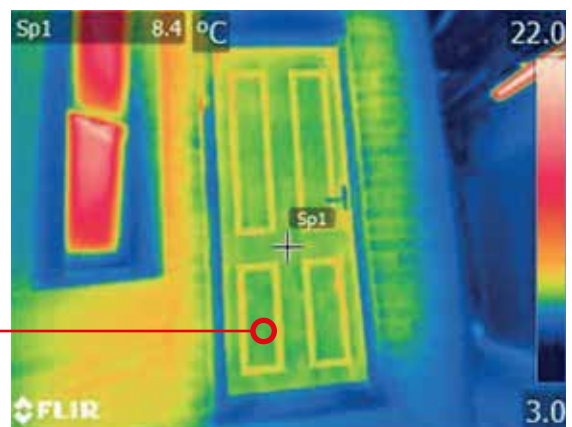

Sanctuary GRP composite door

Doors were tested at the University of Salford's Energy House. This represents a typical Salford 1919 terraced house and its construction represents 21% of the UK's current housing stock. The house has been reconstructed in a fully environmentally controllable chamber, in

which climatic conditions can be maintained, varied, repeated and patterns monitored. For the test, the inside temperature of the Energy House was 25°C with an exterior temperature of 5°C.

Strong and secure

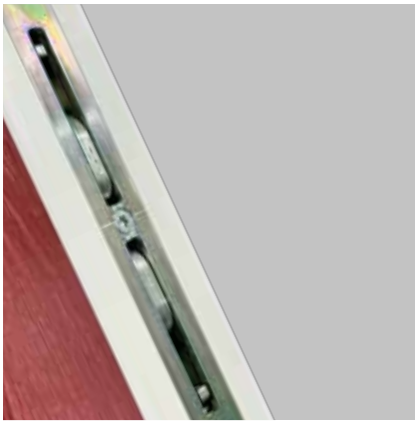

Hook claw locking
Hidden when the door is in use



Opposing hooks are deployed
by raising the door handle



Hooks prevent the door leaf being
pryed open from above and below

Water-resistant

Water-resistant polymer composite rails help keep water absorption away helping prevent any bowing of the door.

Rigid

For improved stability.

Insulated

Tests prove your new door is 17% more thermally efficient than a traditional timber panelled door.

Secure

The reinforced central board gives you extra reassurance that your door is both solid and secure.

Strong

Superior GRP doors have a high impact resistant skin with a beautiful woodgrain finish for an authentic and premium aesthetic.

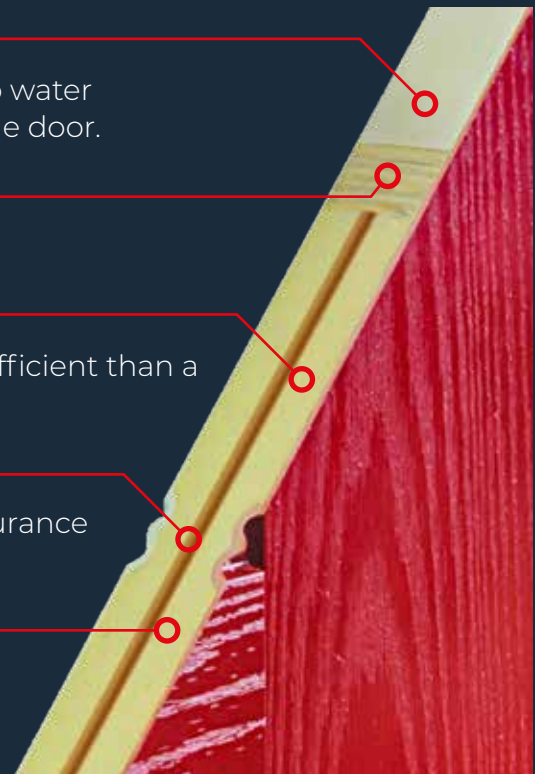

Our composite doors combine glass-reinforced plastic skins with a polymer frame to create a rigid door structure.

In addition, an engineered timber frame adds further strength and rigidity to the door along with a reinforced central core for security.

The remainder of the door uses an insulated foam filling as used in most modern thermally-efficient buildings.

This design offers the perfect balance of style, security and insulation needed in all British homes.

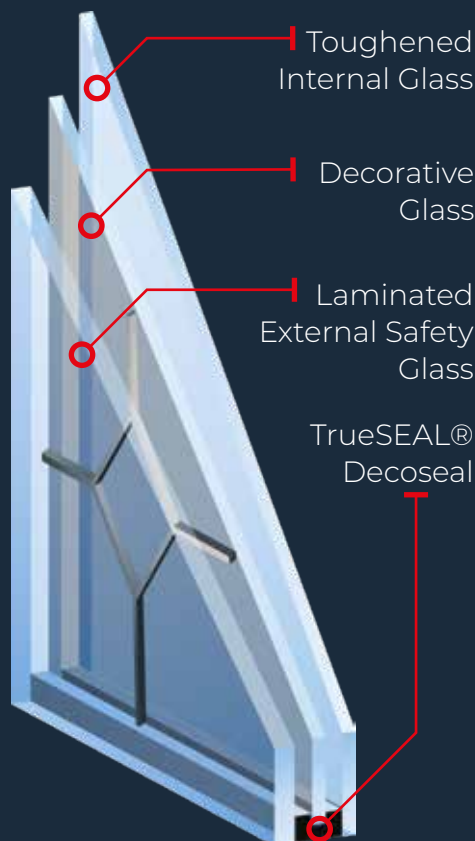

The perfect balance of style, security and insulation

To match these high levels of insulation, a choice of 12 standard decorative glazing units are available, each with differing amounts of obscurity. These glazing units are triple-glazed as standard, using a 6.8mm laminated safety glass (as a car windscreen) on the exterior pane whilst a 4mm toughened interior glass is used on the inside. These panes encapsulate and seal the 4mm decorative glass used inside the glazing unit. The leads and bevels are protected from the elements by being sealed in, making the glass simple to clean from indoors or outdoors.



Choices



ECLAT

Glass designs available

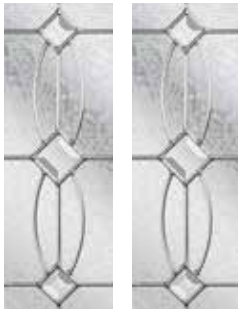

Andorra
Zinc or Brass Cames

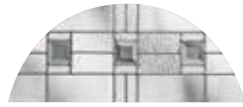

Aspen

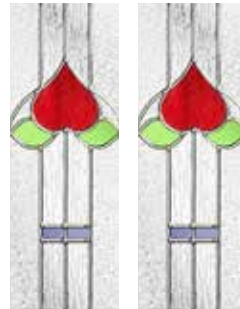

Edwardian

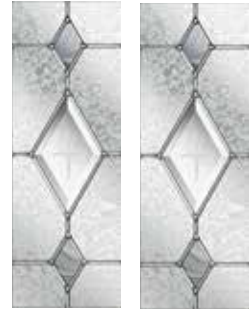

Kara
Zinc or Brass Cames



Lunna



Monza

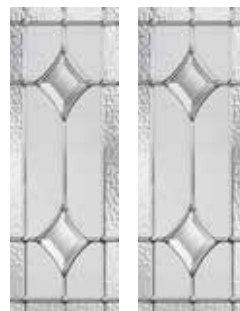
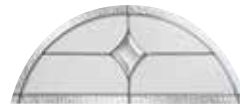

Palma

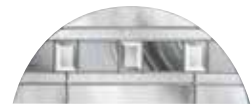

Savana



Scotia
Zinc or Brass Cames



Sierra

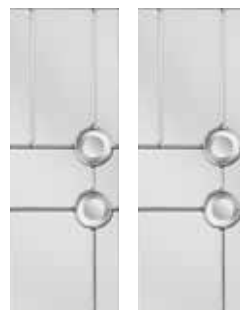

Trieste

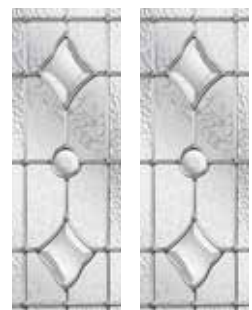
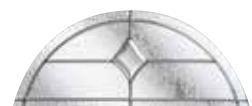

Valentia

Kara Colour Options



Red Blue Green Grey

79

TRADITIONAL



ECLAT ARCH

Glass designs available



Andorra
Zinc or Brass Cames

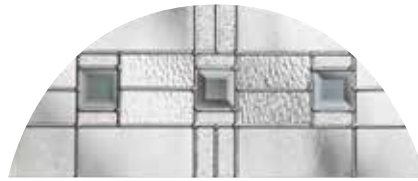

Aspen

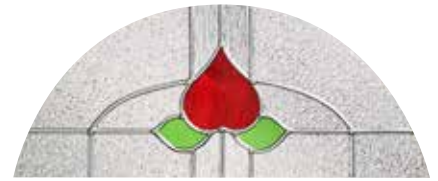

Edwardian



Kara
Zinc or Brass Cames



Lunna



Monza

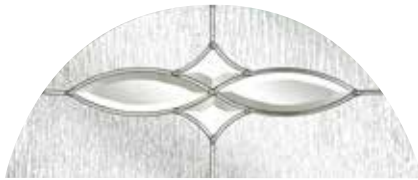

Scotia
Zinc or Brass Cames

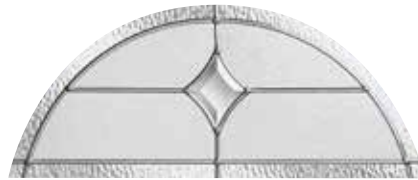

Palma

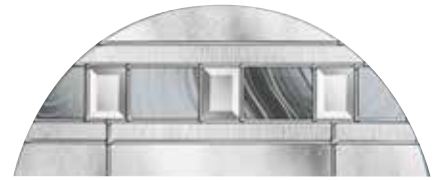

Sierra

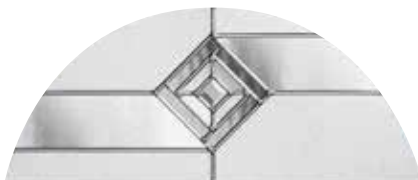

Savana



Trieste



Valentia

ECLAT ARCH with Grid

formerly named 'Eclat Arch Sunburst'

Kara Colour Options



Red Blue Green Grey





ESTEEM

Glass designs available

ESTEEM ARCH

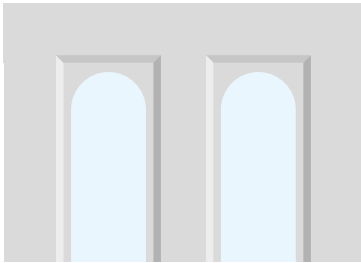

ESTEEM BROW

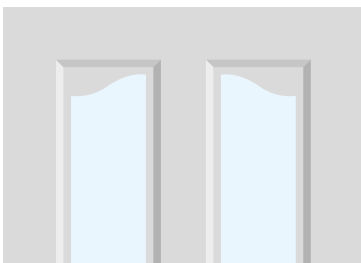

Andorra
Zinc or Brass
Cames



Aspen



Edwardian



Kara
Zinc or
Brass
Cames



Lunna



Monza



Palma



Savana



Scotia
Zinc or
Brass
Cames



Sierra



Trieste



Valentia

Kara Colour Options



Red Blue Green Grey



ELEGANCE

Glass designs available

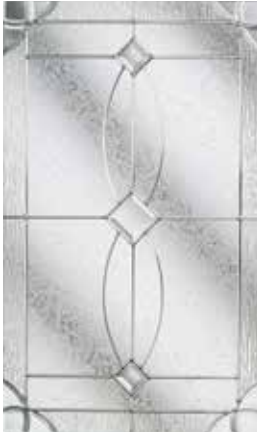

Andorra
Zinc or Brass Cames

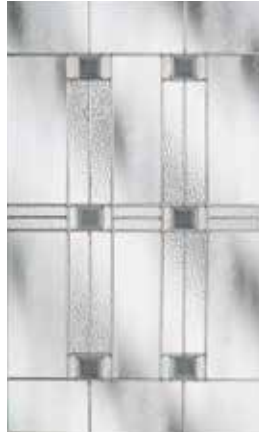

Aspen

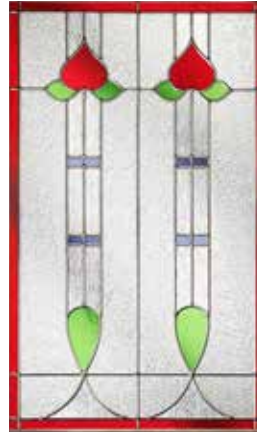

Edwardian



Kara
Zinc or Brass Cames

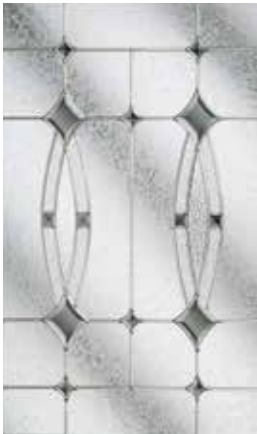

Lunna



Monza

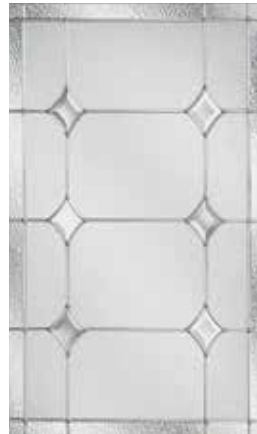

Palma



Savana



Scotia
Zinc or Brass Cames

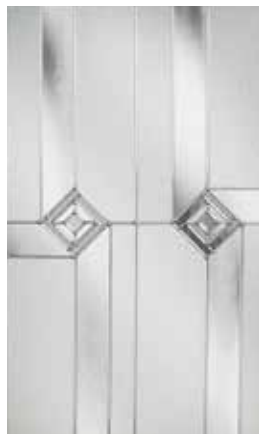

Sierra

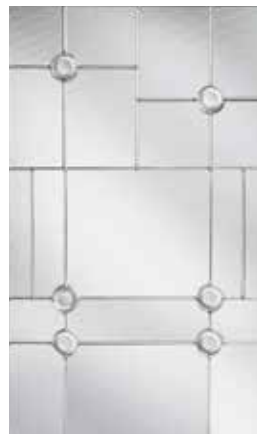

Trieste

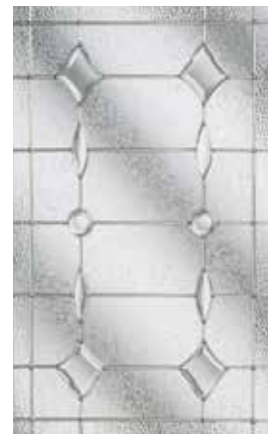

Valentia

Kara Colour Options



Red Blue Green Grey



CLASSICAL 4 GLAZED

Glass designs available

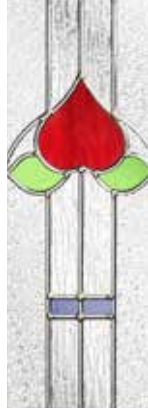

Andorra
Zinc or Brass Cames

Aspen

Edwardian

Monza

Lunna

Kara
Zinc or Brass Cames

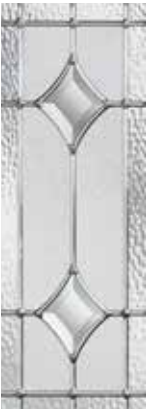

Palma

Savana

Scotia
Zinc or Brass Cames

Sierra

Trieste

Valentia

Kara Colour Options



Red Blue Green Grey





CLASSICAL

Glass designs available



Andorra
Zinc or Brass Cames

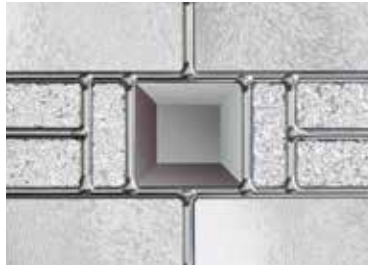

Aspen



Kara
Zinc or Brass Cames

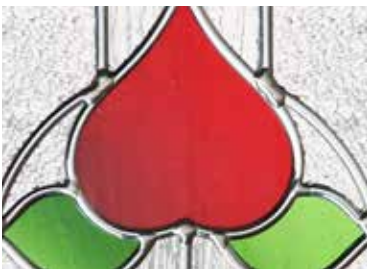

Edwardian

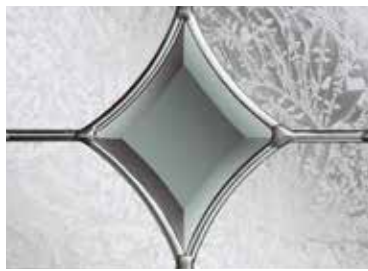

Lunna



Monza

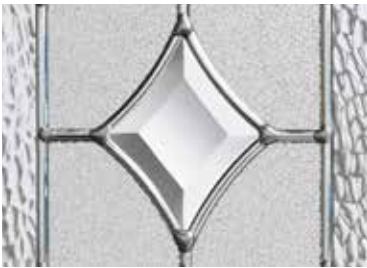

Palma



Savana



Scotia
Zinc or Brass Cames



Sierra



Trieste



Valentia

Kara Colour Options



Red Blue Green Grey



79

TRADITIONAL



ELEGANCE ARCH



Andorra
Zinc or Brass Cames



Aspen

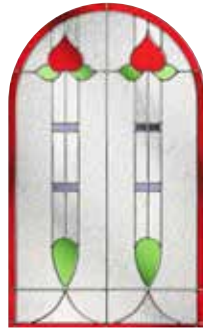

Edwardian



Kara
Zinc or Brass Cames

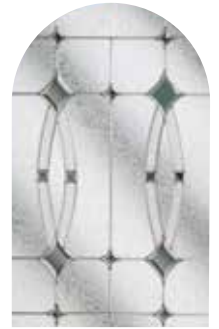

Lunna



Monza



Palma



Savana



Scotia
Zinc or Brass Cames



Sierra



Trieste

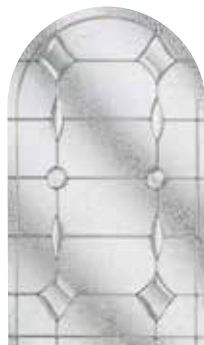

Valentia



Kara Colour Options



Red Blue Green Grey



RENOWN

Glass designs available

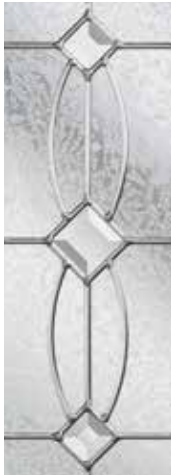

Andorra
Zinc or Brass
Cames



Aspen

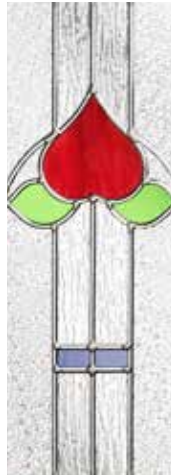

Edwardian



Kara
Zinc or Brass
Cames



Monza



Lunna



Palma



Savana



Scotia
Zinc or Brass
Cames



Sierra



Trieste



Valentia



Kara Colour Options



Red Blue Green Grey



RUSTIC RENOWN

Glass designs available

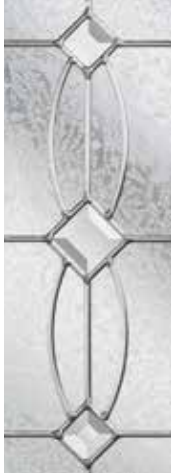

Andorra
Zinc or Brass
Cames



Aspen

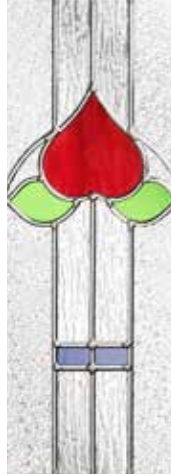

Edwardian



Kara
Zinc or Brass Cames



Monza



Lunna



Palma



Savana



Scotia
Zinc or Brass
Cames



Sierra



Trieste

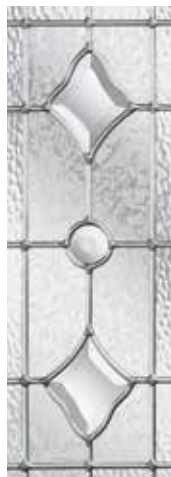

Valentia



Kara Colour Options



Red Blue Green Grey

TRADITIONAL



RENOWN TOP

Glass designs available



Andorra
Zinc or Brass Cames



Aspen



Kara
Zinc or Brass Cames



Lunna

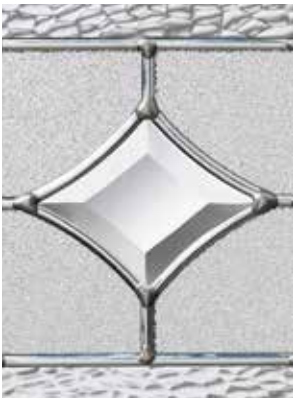

Palma



Scotia
Zinc or Brass Cames



Sierra



Trieste



Kara Colour Options



Red Blue Green Grey

TRADITIONAL



RUSTIC RENOWN TOP

Glass designs available



Andorra
Zinc or Brass Cames



Aspen



Kara
Zinc or Brass Cames



Lunna

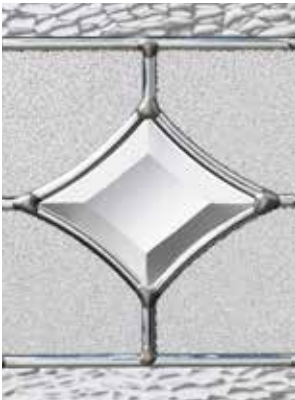

Palma



Scotia
Zinc or Brass Cames



Sierra



Trieste



Kara Colour Options



Red Blue Green Grey

WESTERFIELD
HOUSE



RENOWN DIAMOND

Glass designs available



Andorra
Zinc or Brass
Cames

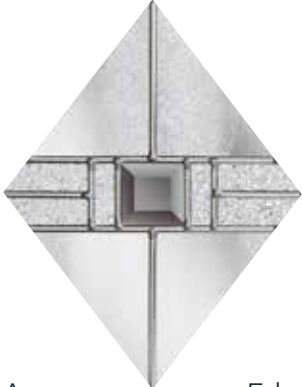

Aspen

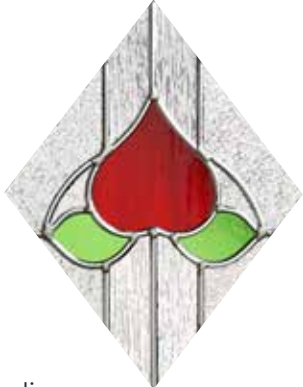

Edwardian



Kara
Zinc or Brass Cames

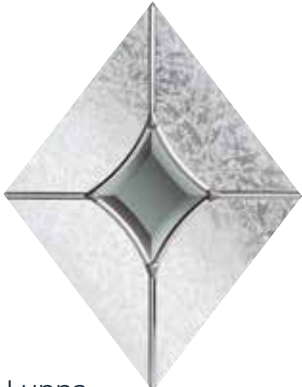

Lunna



Monza



Palma



Savana

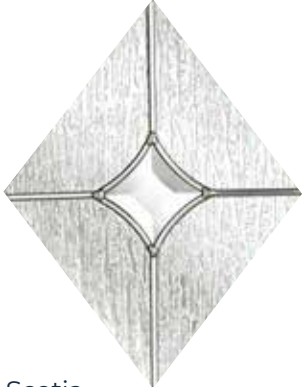

Scotia
Zinc or Brass
Cames



Sierra

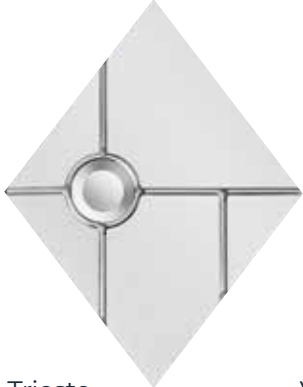

Trieste



Valentia

Kara Colour Options





RUSTIC RENOWN DIAMOND

Glass designs available



Andorra
Zinc or Brass
Cames

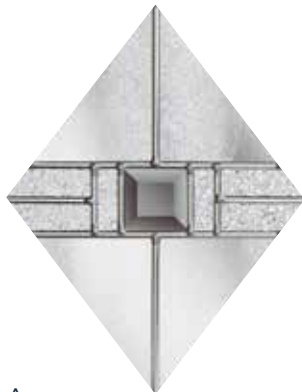

Aspen

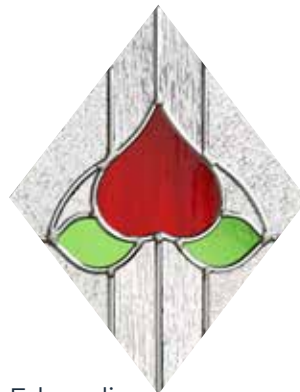

Edwardian



Kara
Zinc or Brass Cames

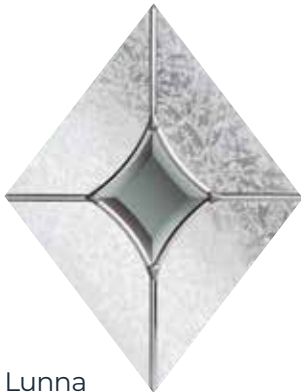

Lunna



Monza

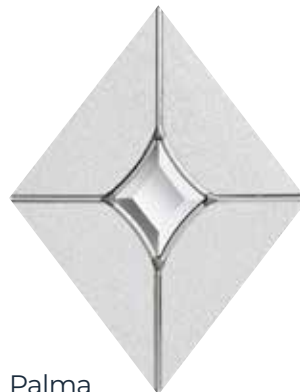

Palma



Savana

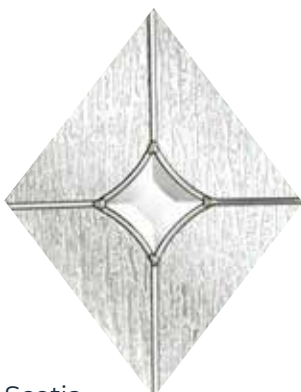

Scotia
Zinc or Brass
Cames



Sierra

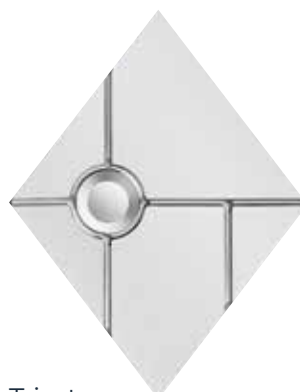

Trieste



Valentia

Kara Colour Options



Red Blue Green Grey

TRADITIONAL



SOLID DOORS



Esteem Solid



Classical Solid



Prestige Solid



Renown Solid



Flush



Rustic Renown Solid

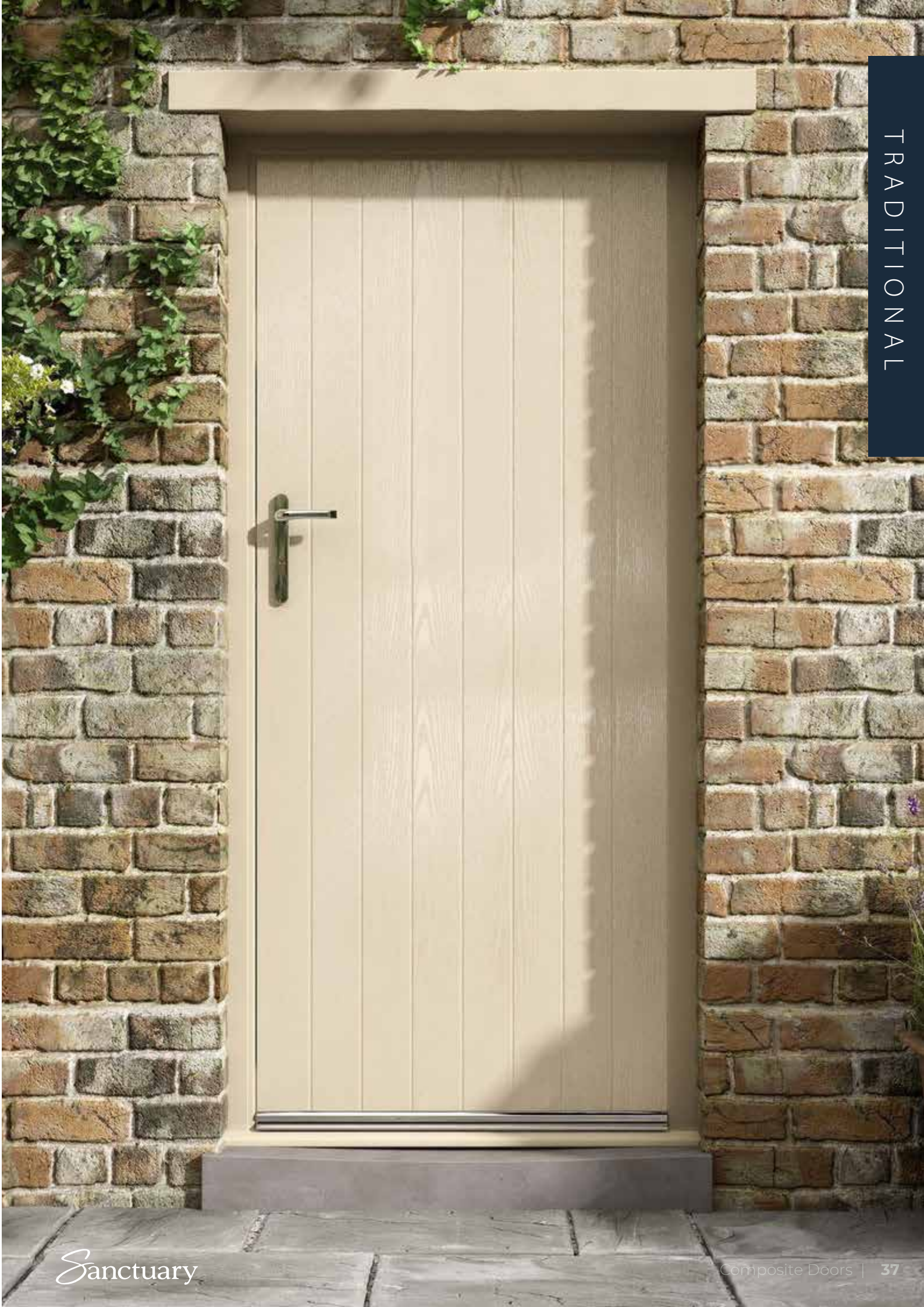

ESPRIT C07L



Esprit C07L
Breeze glass and chrome lever handle

Glass designs available

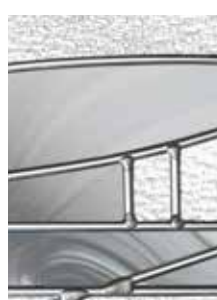
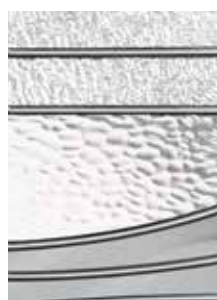
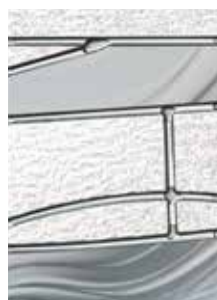
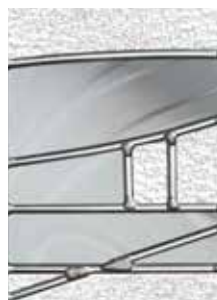

Breeze

Glacier

ESPRIT C07R



Esprit C07R
Glacier glass and finger pull

Clear, Satin and Patterned glass
are also available



ESPRIT C07

ESPRIT C09C



Esprit C09C
Odessa glass and long bar handle

Glass designs available

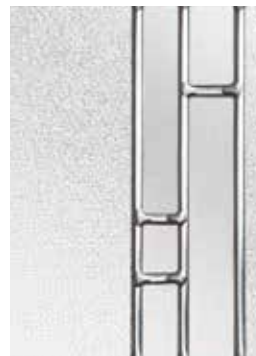
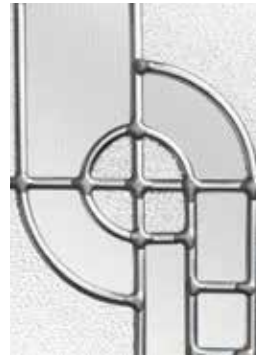

ESPRIT C09L



Esprit C09R
Bloom glass and short bar handle

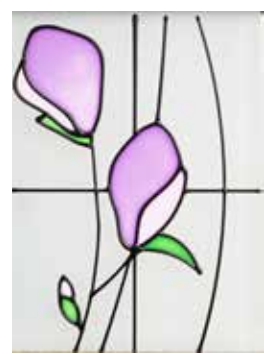
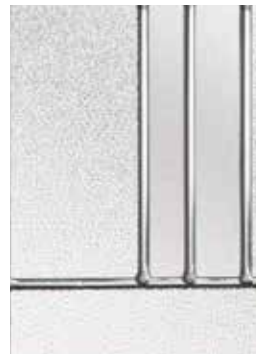
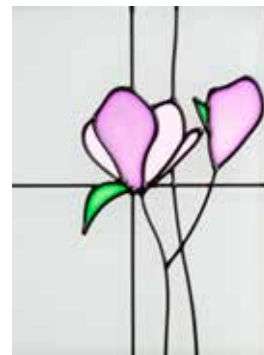
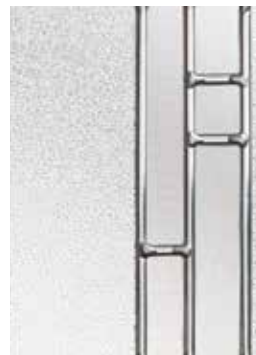

Odessa

Bloom

Clear, Satin and Patterned glass are also available



ESPRIT C09R

ESPRIT C12C



Esprit C12C
Canvas glass and bar handle

Glass designs available

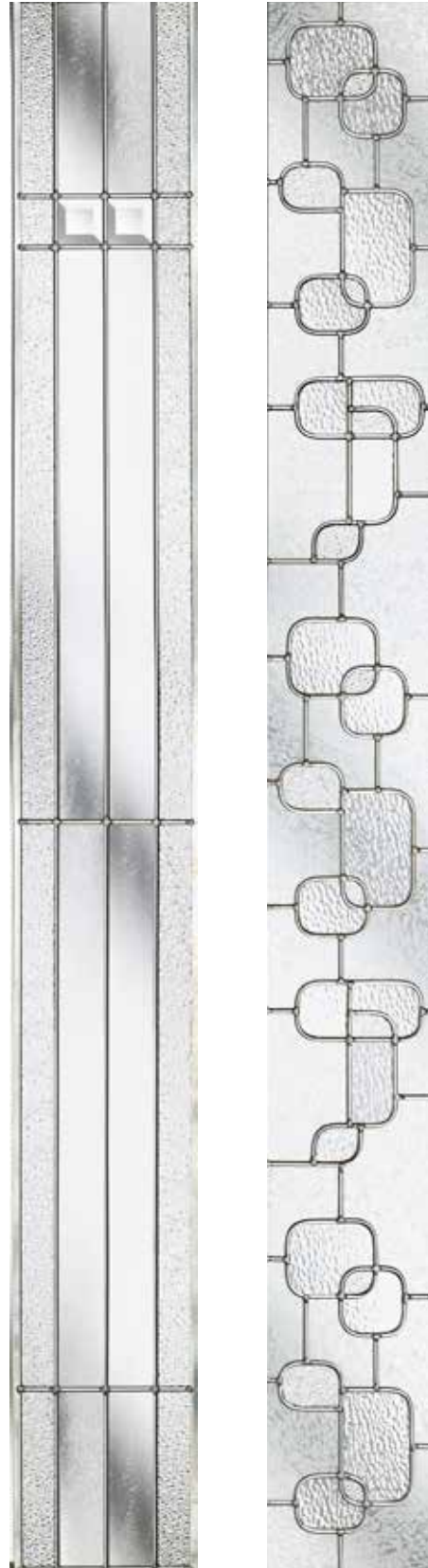

Radiant

Canvas

Clear, Satin and Patterned glass
are also available

ESPRIT C12R



Esprit C12R
Radiant glass and chrome lever handle

ESPRIT C12L

BAUHAUS



ESPRIT C17L



Esprit C17L
Cubic glass and bar handle

Glass designs available

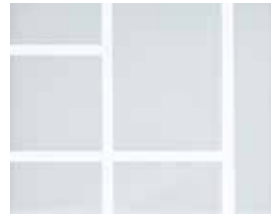

Cubic

Echo

ESPRIT C17R



Esprit C17R
Echo glass with chrome lever handle

Clear, Satin and Patterned glass
are also available



ESPRIT C17C

BAUHAUS



ESPRIT C25



Glass designs available



Blue Stipple



Eclipse



54

ESPRIT C26L



Esprit C26L
Matrix glass and bar handle

Glass designs available

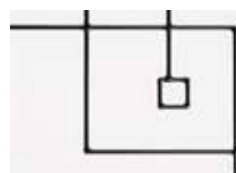
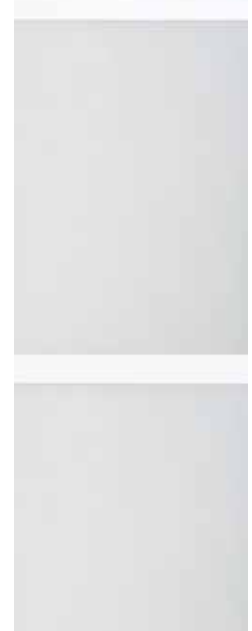
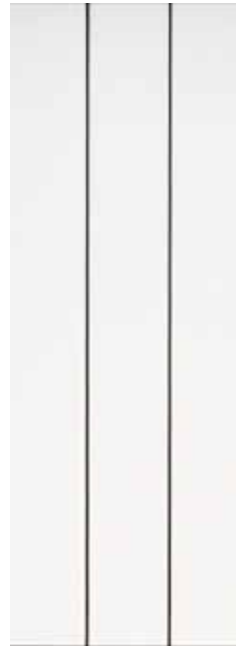
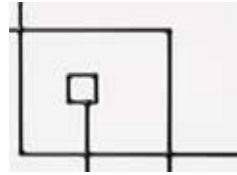

ESPRIT C26R



Esprit C26R
Nevis glass and finger pull

Matrix

Nevis

Clear, Satin and Patterned glass
are also available

ESPRIT C26



Availability

Discover deeper, richer tones; classic and delicate neutrals; and shades designed to bring joy.

Carefully curated in-house, our non-toxic, odourless, low emission and eco-friendly bespoke paint range* offers something different.

You can choose a colour for both inside and out, and they don't need to match.

Disclaimer:

*White, Black, Blue, Green, Red, Rosewood, Gold Oak, Anthracite Grey and Chartwell Green are colours available from stock. Colours shown should be used for guidance only as the limitations in the printing process may mean that colours vary from those illustrated.

	Traditional	Solid	Rustic Renewn	Bauhaus
Black	<input type="checkbox"/>	<input type="checkbox"/>	<input type="checkbox"/>	<input type="checkbox"/>
White	<input type="checkbox"/>	<input type="checkbox"/>	<input type="checkbox"/>	<input type="checkbox"/>
Red	<input type="checkbox"/>	<input type="checkbox"/>	<input type="checkbox"/>	<input type="checkbox"/>
Blue	<input type="checkbox"/>	<input type="checkbox"/>	<input type="checkbox"/>	<input type="checkbox"/>
Green	<input type="checkbox"/>	<input type="checkbox"/>	<input type="checkbox"/>	<input type="checkbox"/>
Anthracite	<input type="checkbox"/>	<input type="checkbox"/>	<input type="checkbox"/>	<input type="checkbox"/>
Chartwell	<input type="checkbox"/>	<input type="checkbox"/>	<input type="checkbox"/>	<input type="checkbox"/>
Bespoke	<input type="checkbox"/>	<input type="checkbox"/>	<input type="checkbox"/>	<input type="checkbox"/>



A splash of colour

Our standard colours



Black



White



Blue



Green



Red



Gold Oak

Our Rustic Renown standard colours



Black



White



Gold Oak



Anthracite Grey



Chartwell Green

Our bespoke colours



RAL 7035
Dove Grey



RAL 7044
Silk Grey



RAL 7038
Agate Grey



RAL 7042
Traffic Grey A



RAL 7005
Mouse Grey



RAL 7012
Basalt Grey



RAL 7015
Slate Grey



Black Brown



BS 20 C 33
Porcelain Blue



RAL 5023
Distant Blue



RAL 5002
Ultramarine Blue



RAL 5011
Steel Blue



BS 16 C 33
Duck Egg



RAL 5018
Turquoise Blue



RAL 6021
Pastel Green



RAL 6002
Leaf Green



RAL 9001
Cream



BS 08 B 17
Honey Beige



RAL 3005
Wine Red



RAL 3003
Ruby Red



RAL 3020
Traffic Red



RAL 4007
Purple Violet



RAL 4010
Telemagenta



RAL 1021
Colza Yellow

12 stunning designs that are laminated for additional security whilst being easy to clean and maintain.



Andorra
Brass or Zinc Cames



Aspen



Edwardian

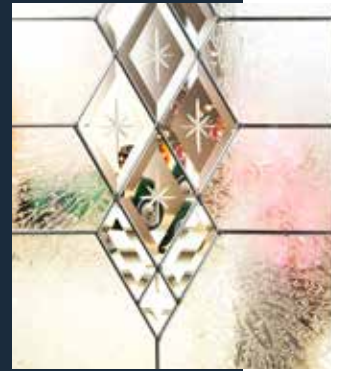

Kara
Brass or Zinc Cames



Lunna



Monza

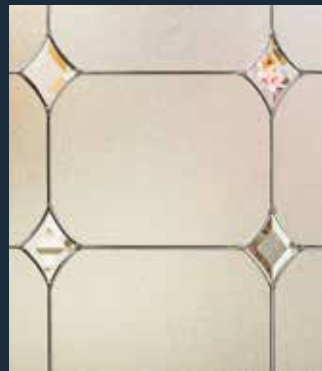

Palma

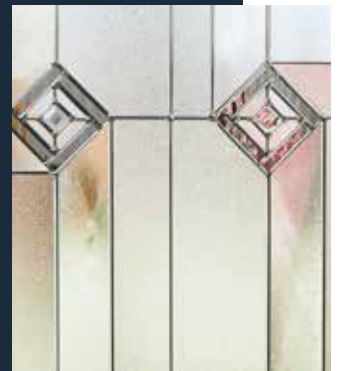

Sierra



Savana



Scotia
Brass or Zinc Cames



Trieste



Valentia

Once you've chosen your door design, it's time to turn your attention to the detailing, deciding which glass design suits your home and whether it allows sufficient privacy.

Seeing the light

Designed to retain heat and expel cold, we offer stunning designs ranging from traditional to contemporary. All of which create the perfect finishing touch.

A decorative glazing unit adds style and individuality to your door whilst allowing natural light into your home.

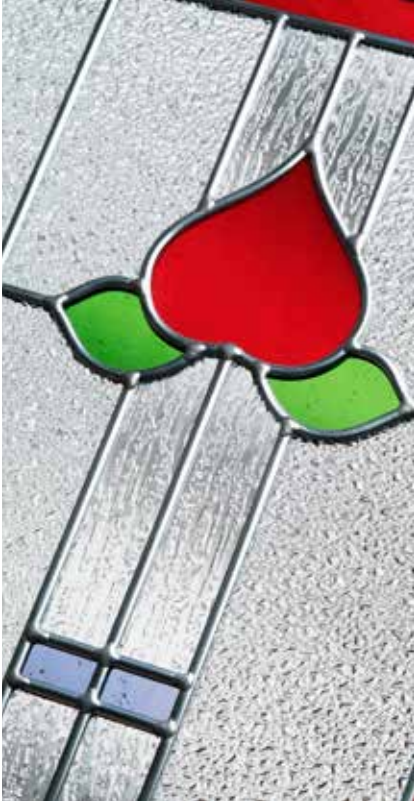

Side-lights

For larger openings, we have a range of matching sidelights that either offer more incoming light whilst retaining privacy, or for restricting all light for complete privacy.

Available across the Traditional range in Esteem, Esteem Arch, Esteem Eyebrow, Elegance Arch and Classical Half Glazed designs.

We have a wide range of hardware available to suit all styles of homes and their individual architecture. Each design is available in it's own range of finishes

which can vary from time to time. Please confirm availability with your Whiteline supplier.

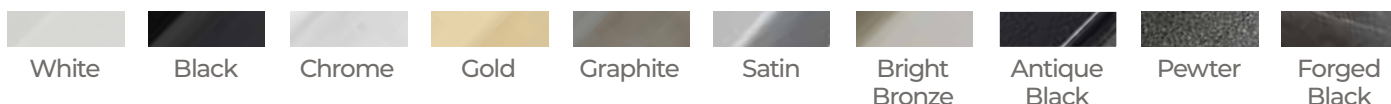

Balmoral
Lever/ lever lockable handle



Balmoral
Lever/ pad lockable handle



Balmoral Swan
Lever/ lever lockable handle



Architectural
Lever/ lever lockable handle



Architectural
Knocker
Antique Black, Graphite, Chrome and Gold only



Contemporary
Knocker



Horse Tail
Knocker



Spire
Knocker
Pewter or Forged Black only

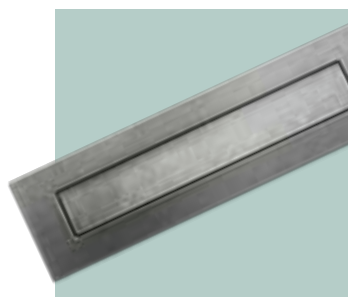

Architectural
Letterplate
Antique Black, Graphite, Chrome and Gold only

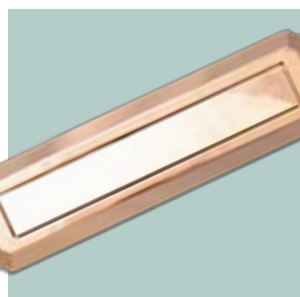

Heritage
Letterplate
Antique Black, Graphite, Chrome and Gold only

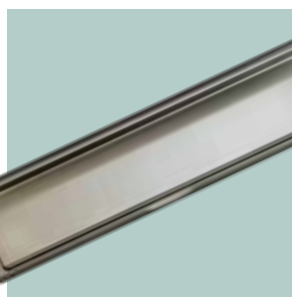

Numail
Letterplate

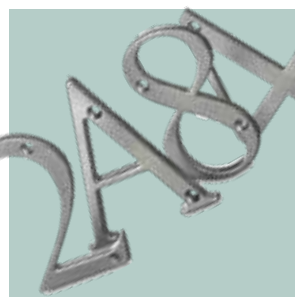

Letters and Numerals
A, B, C, D, E, F and 1, 2, 3, 4, 5, 6, 7, 8, 9

Hardware options



Sculptured
Lever/ lever lockable handle
Pewter or Forged Black only



Monkey Tail
Lever/ lever lockable handle
Pewter or Forged Black only

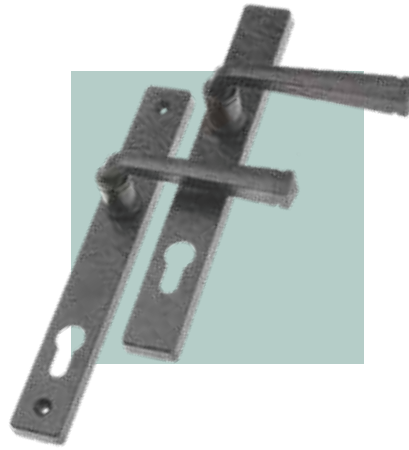

Noble
Lever/ lever lockable handle
Pewter or Forged Black only



Heritage
Lever/ lever lockable handle
Antique Black, Graphite, Chrome and Gold only



Medium Urn with Spyhole
Traditional knocker



Slim Urn with Spyhole
Traditional knocker



Medium Urn
Traditional knocker



Slim Urn
Traditional knocker



Stainless Steel
Offset bar handle
in a choice of lengths



Stainless Steel
Knocker



Stainless Steel
A, B, C, D, E, F and 1, 2, 3, 4, 5, 6, 7, 8, 9

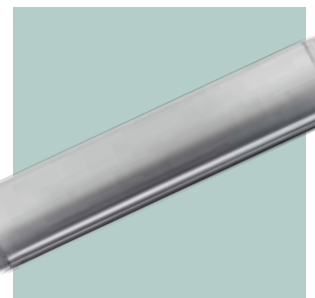

Stainless Steel
Marine-grade 316
Letterplate



*Start designing your
bespoke door with our
door visualiser feature*



<https://build-your-door.com/whiteline/sanctuary/about>



whiteline

t: 0800 652 3151 **w:** whiteline.co.uk

BR0026 Sanctuary Brochure 7th Edition 2024

Door and glass colours shown in this brochure should be used for guidance only as the limitations in photographic and printing processes may mean that colours of products vary from those illustrated. All doors are provided with white internal skins, as standard, although Gold Oak and Rose Wood are also available stained on both sides. All information in this publication is provided for guidance only and is given in good faith. Whiteline reserve the right to alter specifications without prior notice. Reproduction of this brochure in whole or part is strictly forbidden without prior written consent.

Copyright © Whiteline Manufacturing Limited 2024